

JVC



VIDEO CASSETTE RECORDER

HR-J295EK



INSTRUCTIONS

Safety Precautions

The rating plate and the safety caution are on the rear of the unit.

WARNING: DANGEROUS VOLTAGE INSIDE

WARNING: TO PREVENT FIRE OR SHOCK HAZARD, DO NOT EXPOSE THIS UNIT TO RAIN OR MOISTURE.

IMPORTANT

- Please read the various precautions on pages 2–4 of this instruction manual before installing or operating the recorder.
- It should be noted that it may be unlawful to re-record pre-recorded tapes, records, or discs without the consent of the owner of copyright in the sound or video recording, broadcast or cable programme and in any literary, dramatic, musical, or artistic work embodied therein.

IMPORTANT

Connection to the mains supply in the United Kingdom. DO NOT cut off the mains plug from this equipment. If the plug fitted is not suitable for the power points in your home or the cable is too short to reach a power point, then obtain a proper safety approved extension lead/adaptor or consult your dealer.

In the unlikely event of the plug fuse failing be sure to replace the fuse only with an identical approved type, as originally fitted, and to replace the fuse cover. If the fuse fails again consult your nearest JVC dealer.

If nonetheless the mains plug is cut off remove the fuse and dispose of the plug immediately, to avoid a possible shock hazard by inadvertent connection to the mains supply.

If this product is not supplied fitted with a mains plug then follow the instructions given below:

DO NOT make any connection to the Larger Terminal coded E or Green.

The wires in the mains lead are coloured in accordance with the following code:



Blue to N (Neutral) or Black

Brown to L (Live) or Red

If these colours do not correspond with the terminal identifications of your plug, connect as follows:

Blue wire to terminal coded N (Neutral) or coloured Black.

Brown wire to terminal coded L (Live) or coloured Red.

If in doubt — consult a competent electrician.

CAUTION

- When you are not using the recorder for a long period of time, it is recommended that you disconnect the power cord from the mains outlet.
- Dangerous voltage inside. Refer internal servicing to qualified service personnel. To prevent electric shock or fire hazard, remove the power cord from the mains outlet prior to connecting or disconnecting any signal lead or aerial.

The **STANDBY/ON** ⏻/| button does not completely shut off mains power from the unit, but switches operating current on and off. “⏻” shows electrical power standby and “|” shows **ON**.

Video tapes recorded with this video recorder in the LP (Long Play) mode cannot be played back on a single-speed video recorder.

When the equipment is installed in a cabinet or a shelf, make sure that it has sufficient space on all sides to allow for ventilation (10 cm or more on both sides, on top and at the rear.)

When discarding batteries, environmental problems must be considered and the local rules or laws governing the disposal of these batteries must be followed strictly.

Failure to heed the following precautions may result in damage to the recorder, remote control or video cassette.

1. DO NOT place the recorder...

- ... in an environment prone to extreme temperatures or humidity.
- ... in direct sunlight.
- ... in a dusty environment.
- ... in an environment where strong magnetic fields are generated.
- ... on a surface that is unstable or subject to vibration.

2. DO NOT block the recorder's ventilation openings or holes.

(If the ventilation openings or holes are blocked by a newspaper or cloth, etc., the heat may not be able to get out.)

3. DO NOT place heavy objects on the recorder or remote control.

4. DO NOT place anything which might spill on top of the recorder or remote control.

(If water or liquid is allowed to enter this equipment, fire or electric shock may be caused.)

5. DO NOT expose the apparatus to dripping or splashing.

6. DO NOT use this equipment in a bathroom or places with water. Also **DO NOT** place any containers filled with water or liquids (such as cosmetics or medicines, flower vases, potted plants, cups, etc.) on top of this unit.

7. DO NOT place any naked flame sources, such as lighted candles, on the apparatus.

8. AVOID violent shocks to the recorder during transport.

MOISTURE CONDENSATION

Moisture in the air will condense on the recorder when you move it from a cold place to a warm place, or under extremely humid conditions—just as water droplets form in the surface of a glass filled with cold liquid. Moisture condensation on the head drum will cause damage to the tape. In conditions where condensation may occur, keep the recorder turned on for a few hours to let the moisture dry.



- Cassettes marked “VHS” (or “S-VHS”) can be used with this video recorder. However, only VHS recording can be made and played back.
- HQ VHS is compatible with existing VHS equipment.
- VIDEO Plus+ and PlusCode are registered trademarks of Gemstar Development Corporation. The VIDEO Plus+ system is manufactured under license from Gemstar Development Corporation.

Some Do's And Don'ts On The Safe Use Of Equipment

This equipment has been designed and manufactured to meet international safety standards but, like any electrical equipment, care must be taken if you are to obtain the best results and safety is to be assured.

- DO** read the operating instructions before you attempt to use the equipment.
- DO** ensure that all electrical connections (including the mains plug, extension leads and interconnections between pieces of equipment) are properly made and in accordance with the manufacturer's instructions. Switch off and withdraw the mains plug when making or changing connections.
- DO** consult your dealer if you are ever in doubt about the installation, operation or safety of your equipment.
- DO** be careful with glass panels or doors on equipment.
- DON'T** continue to operate the equipment if you are in any doubt about it working normally, or if it is damaged in any way — switch off, withdraw the mains plug and consult your dealer.
- DON'T** remove any fixed cover as this may expose dangerous voltages.
- DON'T** leave equipment switched on when it is unattended unless it is specifically stated that it is designed for unattended operation or has a standby mode. Switch off using the switch on the equipment and make sure that your family knows how to do this. Special arrangements may need to be made for infirm or handicapped people.
- DON'T** use equipment such as personal stereos or radios so that you are distracted from the requirements of road safety. It is illegal to watch television whilst driving.
- DON'T** listen to headphones at high volume, as such use can permanently damage your hearing.
- DON'T** obstruct the ventilation of the equipment, for example with curtains or soft furnishings. Overheating will cause damage and shorten the life of the equipment.
- DON'T** use makeshift stands and NEVER fix legs with wood screws — to ensure complete safety always fit the manufacturer's approved stand or legs with the fixings provided according to the instructions.
- DON'T** allow electrical equipment to be exposed to rain or moisture.

ABOVE ALL...

- **NEVER** let anyone especially children push anything into holes, slots or any other opening in the case — this could result in a fatal electrical shock;
- **NEVER** guess or take chances with electrical equipment of any kind — it is better to be safe than sorry!

Contents

Diagrams of Equipment	6
Equipment Key	7
Welcome to JVC	8
Plug&Play Setup	10
Initial Settings	13
Basic Features	23
Advanced Features	37
Subsidiary Information	45
List of Terms	49

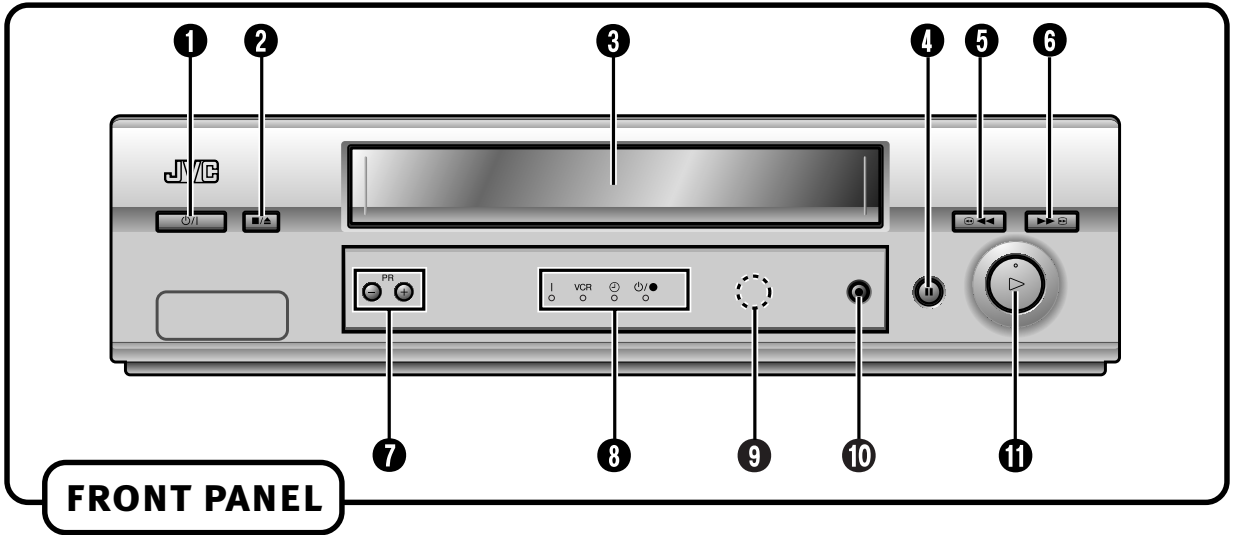

FRONT PANEL

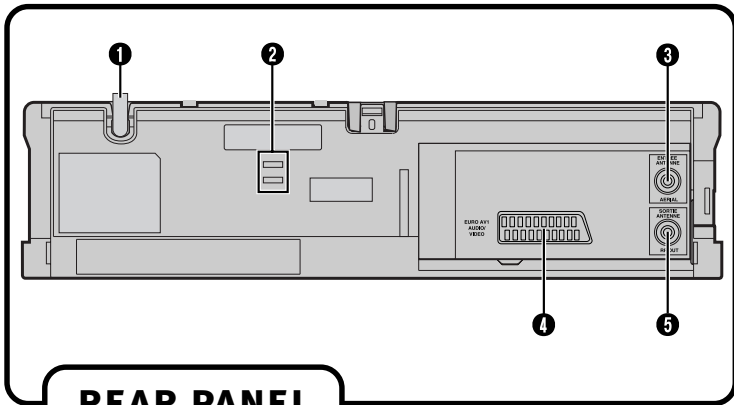

REAR PANEL

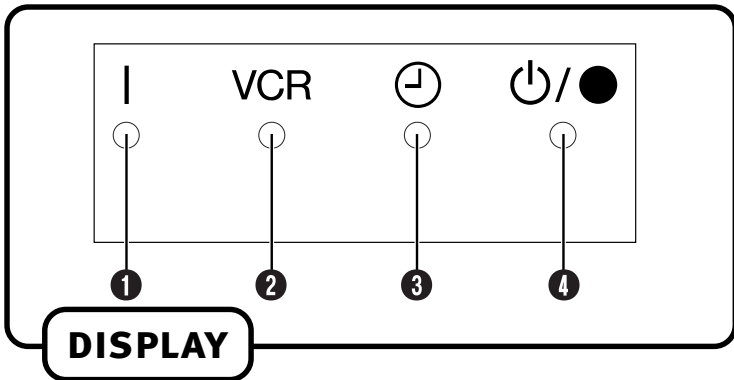

DISPLAY

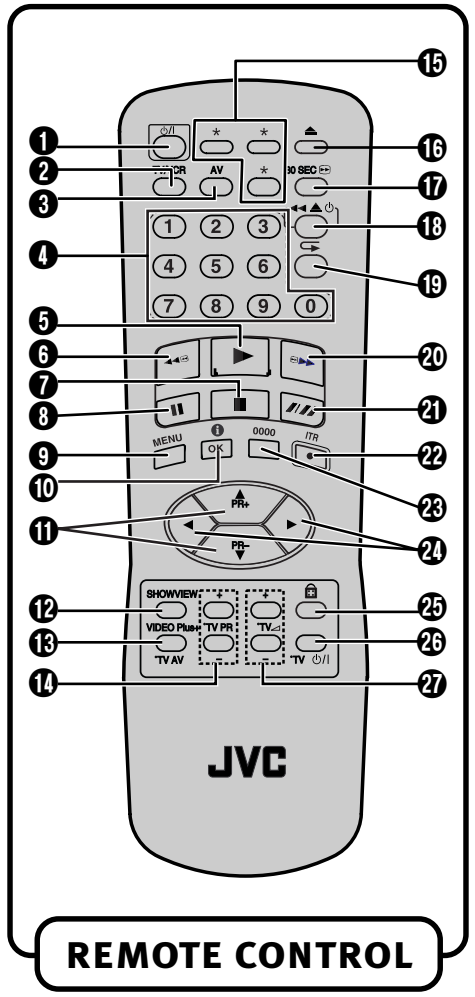

REMOTE CONTROL

Diagram Key

FRONT PANEL

- 1 **STANDBY/ON**  Button turns VCR on/off (loading a cassette also turns power on).
- 2 **■/▲** Button stops tape; ejects tape during Stop mode.
- 3 **Cassette Loading Slot** is where cassette is inserted; door closes.
- 4 **||** Button stops tape temporarily during recording; stops tape temporarily during playback.
- 5 **◀◀** Button rewinds the tape; initiates high-speed reverse search.
- 6 **▶▶** Button fast-forwards tape; initiates high-speed forward search.
- 7 **PR +/-** Buttons select a preset position.
- 8 **Display Panel** shows the condition of the VCR.
- 9 **Infrared Beam Receiving Window** is where Remote Control should be aimed when in use.
- 10 **●** Button starts regular recording.
- 11 **▶** Button plays back tape; cancels Pause, Still, Search modes.







REAR PANEL

- 1 **Mains Power Cord** supplies power to VCR.
- 2 **Tying Band Stopper** fixes the main power cord. Do not drop the tying band into the inside of the VCR. It may cause a malfunction.
- 3 **AERIAL Connector** enables connection of aerial.
- 4 **EURO AV1 AUDIO/VIDEO Connector** enables AV connection to TV or second VCR; input recordable when AV1 selected.
- 5 **RF. OUT Connector** enables connection to aerial terminal of TV receiver.

VCR DISPLAY PANEL

- 1 **Power Indicator** lights up when the VCR is turned on.
- 2 **VCR Indicator** lights when the VCR is in the video mode. At this point, the TV automatically enters AV mode.
- 3 **Timer Indicator** lights when the VCR enters Timer mode.
- 4 **Standby/Record Indicator** lights when the VCR is in standby mode or during recording.

REMOTE CONTROL

- 1 **STANDBY/ON**  Button turns VCR on/engages the VCR in the standby mode.
- 2 **TV/VCR Button** switches connected TV's mode between TV and AV.
- 3 **AV Button** selects VCR's auxiliary input mode.
- 4 **Number Keys** are used in preset position selection and the VIDEO Plus+ Timer Programming.
- 5 **▶** Button — same as button on VCR.
- 6 **◀◀** Button — same as button on VCR.
- 7 **■** Button stops tape.
- 8 **||** Button — same as button on VCR.
- 9 **MENU Button** accesses Menu screen.
- 10 **OK**  Button enters selections made in on-screen menus; displays the current VCR status on the TV screen.
- 11 **△▽ [PR+/-] Buttons** select a preset position; used for selection in on-screen menus; adjust the tracking during playback or still picture.
- 12 **VIDEO Plus+ Button** accesses VIDEO Plus+ Program screen.
- 13 **TV AV Button** enables Remote Control of your JVC TV.
- 14 **TV PR +/- Buttons** selects the connected JVC TV's channel.
- 15 *** Buttons** are not available with this VCR.
- 16 **▲** Button ejects tape during Stop mode.
- 17 **30 SEC**  Button initiates a 30-second period of fast-motion playback.
- 18 **◀◀▲**  Button initiates Ez (Easy) Power Off function.
- 19 **↺** Button initiates Ez (Easy) repeat playback.
- 20 **▶▶** Button — same as button on VCR.
- 21 **///** Button selects tape speed.
- 22 **● [ITR] Button** starts regular recording (press once), Instant Timer Recording (press twice); sets duration of ITR.
- 23 **0000 Button** resets counter on the on-screen display to '0:00:00'.
- 24 **◀▷** Buttons used for selection in on-screen menus.
- 25 **🔒** Button enables/disables the child lock mode.
- 26 **TV**  Button turns JVC TV on/off.
- 27 **TV**  +/- Buttons control volume of connected JVC TV.

ATTENTION:

To mobile phone users:

Using a mobile phone in the vicinity of the VCR may cause picture vibration on the TV screen or change the screen to a blue back display.

On placing the VCR:

Some TVs or other appliances generates strong magnetic fields. Do not place such appliance on top of the VCR as it may cause picture disturbance.





About Button

When you press  on the VCR and remote control while the VCR is turned on, each button works differently.

On the VCR



When you press , the VCR is turned off completely.

On the Remote Control

When you press , the VCR enters the standby mode.  /  lights on the display panel. To turn off the VCR completely, press  on the VCR.

How to use the Remote Control

Before use, insert the batteries in the correct directions as indicated under the battery cover. The Remote Control can operate most of your VCR's functions, as well as basic functions of JVC TV sets.

- Point the Remote Control toward the receiving window on the VCR.
- The maximum operating distance of the Remote Control is about 7.5 m.
- To operate your JVC TV, press the corresponding button: **TV** , **TV AV**, **TV PR +/-**, **TV**  +/- (TV Volume).

NOTE:

If the Remote Control does not work properly, remove its batteries, wait for a few seconds, replace the batteries and then try again.

Welcome to JVC

Thank you for choosing JVC.

We hope that you will get many hours of enjoyment from your new unit.



Getting Everything Ready

BEFORE YOU START

Please read the **SAFETY FIRST** on pages 2–4 it tells you about some safety points

Refer to the diagrams on pages 6–7 when reading through these instructions

Refer to the **List of Terms** on page 49 if you need an explanation for any terms in this manual

CHECK THE CONTENTS Unpack the box and place the VCR on a flat, stable surface. Check that you have the items shown below.



Video Cassette Recorder

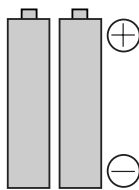

AAA Batteries x 2



RF Cable

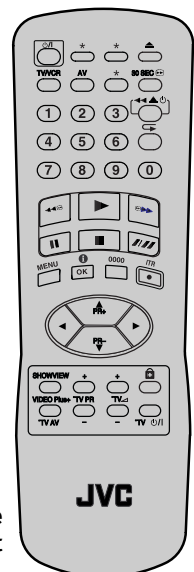

Infrared Remote Control Unit

GETTING EVERYTHING READY (continued)

CONNECT CABLES Connect the cables as indicated in the diagram (below), using the TV Aerial Cable, the RF Cable and the 21-pin SCART Cable (not provided).

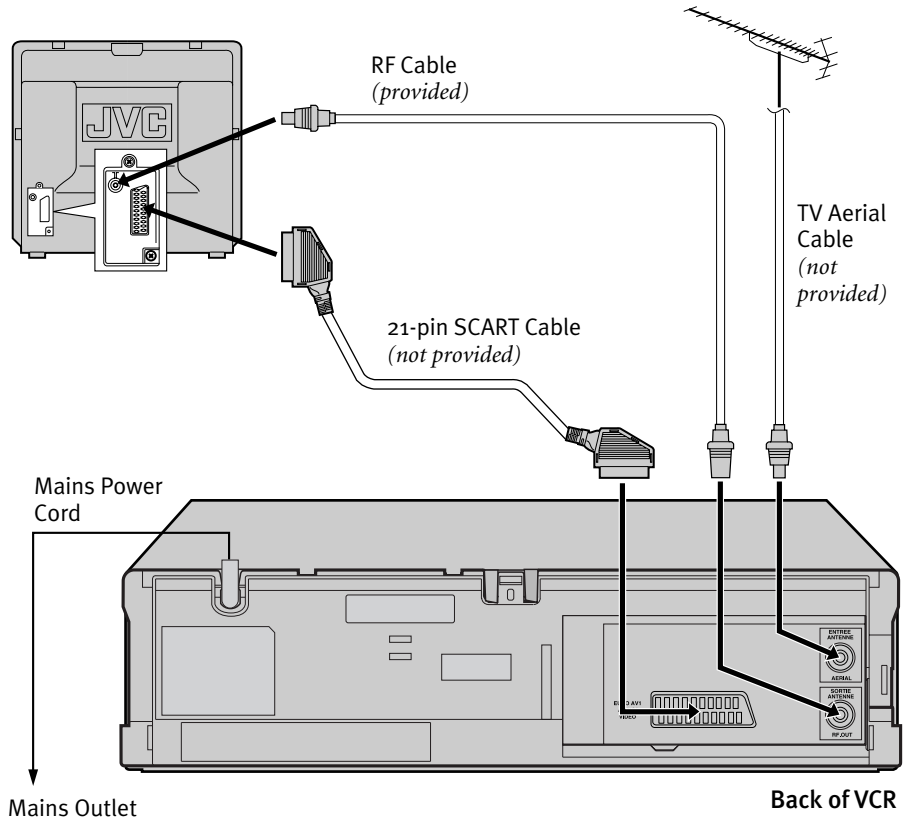
**SCART AND RF**

SCART is a recommended option because its use improves the quality of the picture. If connecting to a stereo TV you will need a SCART cable. There are several types of SCART cables, fully-wired and others.

If you use a SCART cable, you must also connect the RF cable.

You are now ready to start the Plug&Play Setup which begins on the next page.

Do not turn on the VCR. When the main power cord is first plugged into a main outlet, the VCR performs Plug&Play Setup. (ⓘ pg. 10)

Plug&Play Setup

The TV should be set to its AV mode (if you are using both the RF cable and 21-pin SCART cable for connection) or UHF channel 22 (if you are using only RF cable for connection).

1 2 3 Start Plug&Play Setup

BEFORE YOU START

Check that the connection is completed

Tune the TV to your Video Channel or to its AV mode

Load the batteries into the Remote Control

Refer to the Remote Control diagram on pages 6–7

Unless indicated otherwise, use the buttons on the Remote Control

Plug the mains power cord into a mains outlet.

NOTE Do not turn on the VCR or do not press any buttons on the VCR or Remote Control.

WHAT WILL HAPPEN? The Plug&Play screen appears on the TV screen. Then press **OK**.

NOTE: If you have connected your TV to the VCR with only the RF cable and the on-screen display appearing on UHF channel 22 looks distorted, perform “**Video Channel Set**” on page 14.

The VCR is automatically setting up the tuner channels. This only happens the first time that you plug the main power cord into the main outlet.

When Plug&Play is completed, the Confirmation screen appears.

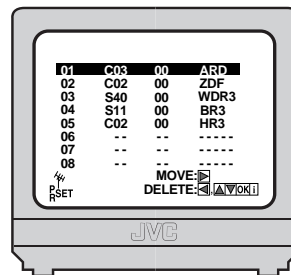
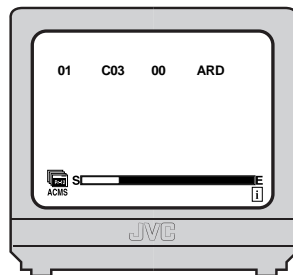
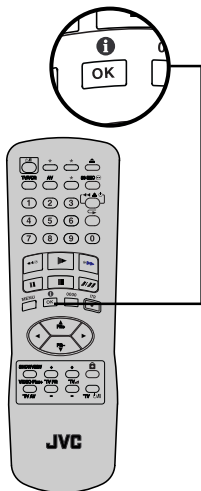
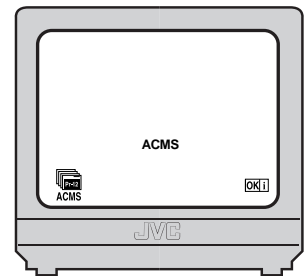

1 2 3 Check the Results

Make sure that all necessary stations have been stored in the VCR's memory by using the Δ and ∇ buttons.

If station names (ID — [pg. 21](#)) have also been stored in the VCR's memory, the station name will be displayed on the TV screen.

1 2 3 Finish Off

RETURN TO NORMAL SCREEN Press **MENU**.

The Tuner Set is completed.

IMPORTANT

- **RE-RUNNING SETUP** Plug&Play Setup may not behave as described if it has already been run on the VCR. This is because some of the information gathered on the first Plug&Play Setup is retained in memory and that part of the process may be skipped by the VCR.
- **DUPLICATE STATIONS** You may be able to receive the same station from two different transmitters in which case Plug&Play Setup will detect and store both. It is normal for one transmitter to give you a better quality picture than the other; to delete those stations which have a poor picture [Delete A Channel](#) on page 19.
- **MANUAL STATION SETTING** If any of the above problems occur, refer to page 19 to input station names ([Change Station Name](#)). You can also change station preset positions ([pg. 20, Change Station Preset Position](#)).

IF YOU HAVE ANY DIFFICULTY WITH THE ABOVE PROCEDURES CALL THE JVC CUSTOMER SERVICE HOT LINE ON 0870 330 5000

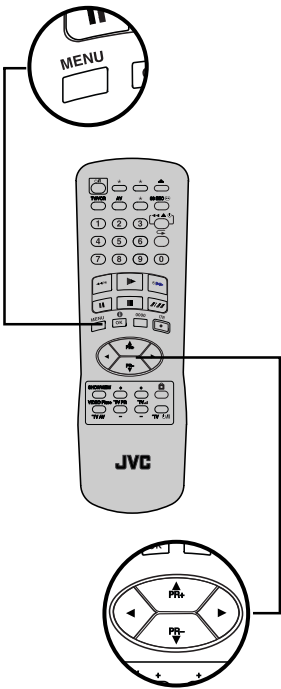

Initial Settings

Video Channel Set	14
Language Set	15
Clock Set	16
Tuner Set	17

Video Channel Set

BEFORE YOU START

The power cord must be plugged in and connected to the VCR

The VCR must be turned on

The Remote Control must have batteries inserted

The TV set must be turned on

The VCR can send picture signals to the TV set in one of two ways; RF (ordinary cable included with this VCR) and AV (via a 21-pin SCART cable available from TV and Hi-Fi dealers). Depending upon which method you use, the VCR must have the correct method set up in order to work. The Video Channel is originally set to channel 22 but if for any reason this fails to happen, the instructions below describe how to set the Video Channel manually.

1 Set channel on TV

Select the vacant position 22 on you TV.

2 Access Video Channel Set Mode

Press $\phi/|$ button on the Remote Control to enter the standby mode. Press and hold **PR+** or **-** on the VCR for more than 3 seconds.

3 Set Video Channel

IF YOU ARE USING BOTH THE RF CABLE AND 21-PIN SCART CABLE FOR CONNECTION Press **PR+** or **-** to set the Video Channel to OFF.

IF YOU ARE USING ONLY THE RF CABLE FOR CONNECTION Press **PR+** or **-** to set the Video Channel to a vacant position between 22 and 68 which is not occupied by any station in your area (refer to station list on page 22).

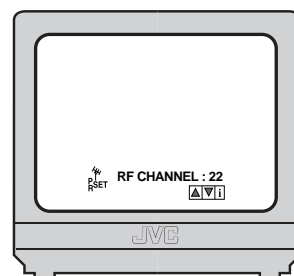

4 Exit Video Channel Set Mode

Press $\phi/|$.

To view pictures from your VCR you must now set your TV to either the Video Channel or to AV mode, depending upon your choice above.

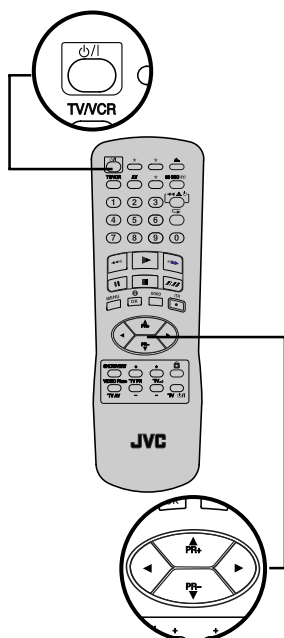

Language Set

BEFORE YOU START

The Remote Control must have batteries inserted

The TV set must be turned on

Tune the TV to your Video Channel or to its AV mode

You can change the language setting manually as required.



Setting the language

GET TO THE MAIN MENU Press **MENU**. Select the icon **ABC OSD** using the \triangleleft and \triangleright buttons and press **OK**.

SELECT LANGUAGE Press the \triangle and ∇ buttons to select the desired language and press \triangleleft and \triangleright .

ENGLISH	English
RUSSIAN	Russian
DEUTCH	German
FRANCAIS	French
POLSKI	Polish

RETURN TO NORMAL SCREEN Press **MENU**.

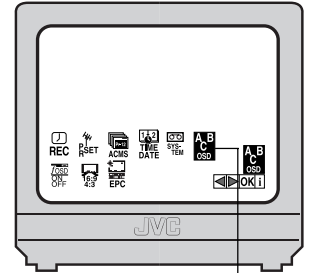

ABC OSD

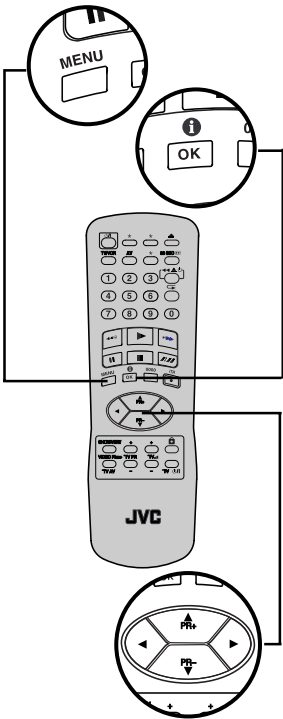

Clock Set

BEFORE YOU START

The Remote Control must have batteries inserted

The TV set must be turned on

Tune the TV to your Video Channel or to its AV mode

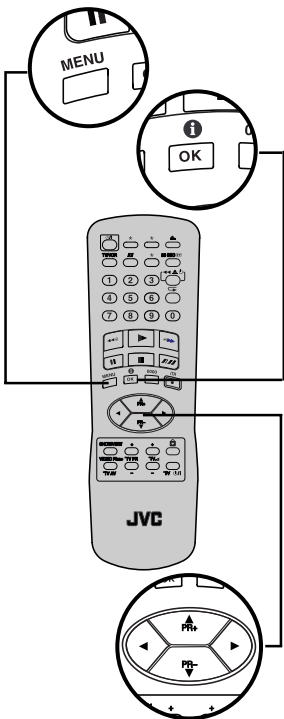

Setting the Clock

GET TO THE MAIN MENU Press **MENU**. Select the icon **TIME DATE** using the ◀ and ▶ buttons and press **OK**.

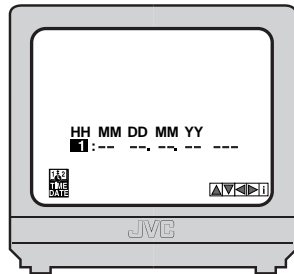

SET TIME AND DATE

Press the ▲ and ▼ buttons to display the desired setting and press ▶.

OR

Press the appropriate number keys for each setting. Input "0" before any single number entries.

START CLOCK OPERATION Press **MENU**.

TIME DATE

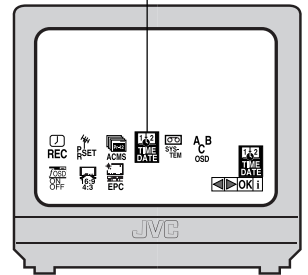

Tuner Set

The VCR needs to find, identify and memorise all available stations in your area in order to record programmes correctly. Once done, pressing the \triangle or ∇ buttons enables you to jump to the available channels without going via any vacant channels. This channel search can be done either automatically or manually. You should only need to perform either of the following procedures if Plug&Play Setup has failed to identify and record available channels or you have moved to a new area.



Auto Channel Setup

GET TO THE MAIN MENU Press **MENU**.

PERFORM AUTO CHANNEL SET Select the icon **ACMS** using the \triangleleft and \triangleright buttons and press **OK** twice.

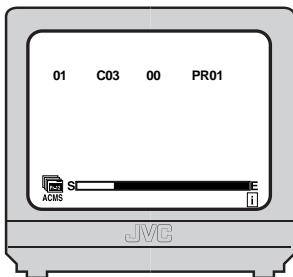

During Auto Channel Set the indicator on the TV screen moves from left to right. When Auto Channel Set is completed, the Confirmation screen appears.

showing the details (*Preset Number, Channel Number, Fine Tuning Condition and Station*) of the TV stations that the process has found. To view the next channel, press the \triangle and ∇ buttons to move the highlight bar to the required channel.

RETURN TO NORMAL SCREEN Press **MENU**.

POOR RECEPTION The VCR memorises all stations found regardless of their quality. If a station's quality is poor, you can delete that station from the memory (*see page 19*).

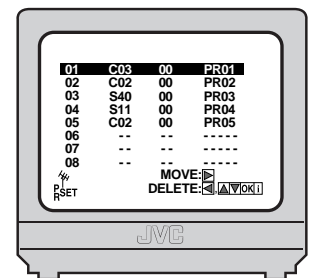
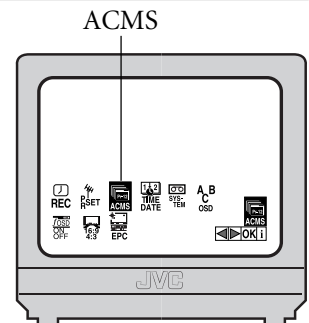



Manual Channel Setup

GET TO THE MAIN MENU Press **MENU**. Select the icon **PR SET** using the ◀ and ▶ buttons and press **OK**. The Manual Channel Set screen of the channel position currently received appears.

GET TO THE CONFIRMATION SCREEN Press **MENU**.

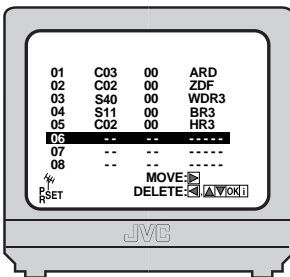
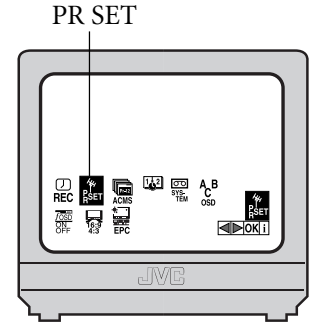

SELECT POSITION Press the △ and ▽ buttons on the Remote Control to select a vacant position then press **OK**. In this example, we have chosen position 6.

SELECT BAND When the **MANUAL CH SET** screen appears, press **AV** to change the band between C (regular) and S (cable).

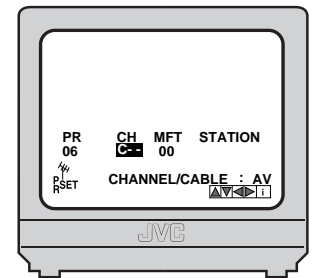

INPUT CHANNEL NUMBER Press the △ and ▽ buttons to input the Channel Number that you want to store and press ▶.

OR

Press the number keys to input the Channel Number that you want to store. Input “o” before any single number entries.

FINE TUNING Press ▶ to select **MFT** setting. Press the △ and ▽ buttons to fine-tune the channel.

INPUT CHANNEL ID Press ▶ to select **STATION** setting and press **OK**. Press the △ and ▽ buttons to select the required ID from the stored list.

SAVE NEW CHANNEL DETAILS Press **MENU** to save the details you have just entered. The Confirmation Screen will appear again. Repeat the above procedure from **Select Position** onwards as many times as required.

CLOSE CONFIRMATION SCREEN Press **MENU**.



Change Station Name

GET TO THE MAIN MENU Press **MENU**. Select the icon **PR SET** using the \triangleleft and \triangleright buttons and press **OK**. The Manual Channel Set screen of the channel position currently received appears.

GET TO THE CONFIRMATION SCREEN Press **MENU**.

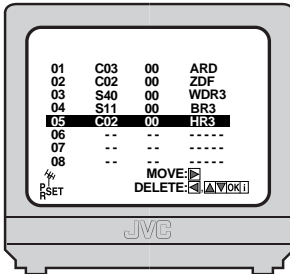

SELECT POSITION Press the \triangle and ∇ buttons on the Remote Control to select the preset position then press **OK**.

SELECT CHARACTER Press \triangleright to select **STATION** setting and press **OK**. Press \triangleright until the first letter of the station name begins blinking.

ENTER NEW CHARACTER Press the \triangle and ∇ buttons to cycle through the characters (A–Z, 0–9, +, -, . (period),

␣(space)) and stop when the desired character is indicated, then press \triangleright to enter. Enter the remaining characters the same way (maximum of 5). After entering all characters, press **OK**.

- If you make a mistake, press \triangleleft until the incorrect character begins blinking. Then enter the correct character by pressing the \triangle and ∇ buttons.

CHECK SETTING Press **MENU**. The Confirmation screen appears.

CLOSE CONFIRMATION SCREEN Press **MENU**.

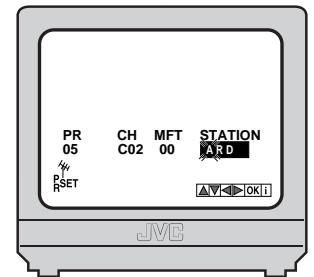
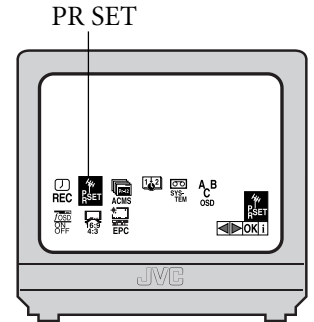

Delete a Channel

GET TO THE MAIN MENU Press **MENU**. Select the icon **PR SET** using the \triangleleft and \triangleright buttons and press **OK**. The Manual Channel Set screen of the channel position currently received appears.

GET TO THE CONFIRMATION SCREEN Press **MENU**.

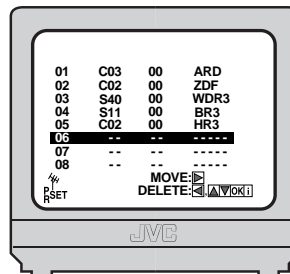

SELECT CHANNEL Press the \triangle and ∇ buttons on the Remote Control to select the channel that you wish to delete.

DELETE CHANNEL Press \triangleleft . The channel directly beneath the cancelled one moves up one line.

RETURN TO NORMAL SCREEN Press **MENU**.

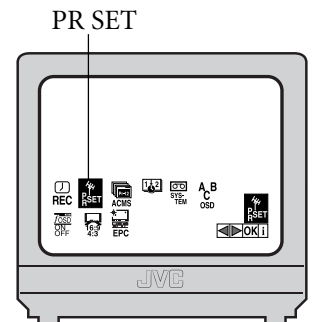



Change Station Preset Position

GET TO THE MAIN MENU Press **MENU**. Select the icon **PR SET** using the **◀** and **▶** buttons and press **OK**. The Manual Channel Set screen of the channel position currently received appears.

GET TO THE CONFIRMATION SCREEN Press **MENU**.

SELECT ITEM Press the **△** and **▽** buttons on the Remote Control to select the item you want to move then press **▶**.

SELECT NEW POSITION Press the **△** and **▽** buttons to move the station to the new preset position, then press **OK**.

PR SET

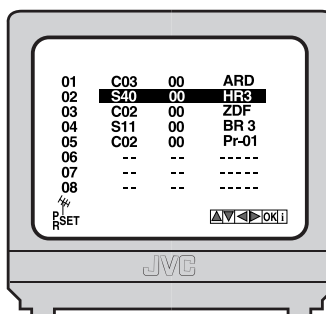
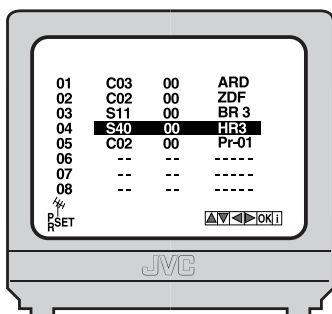
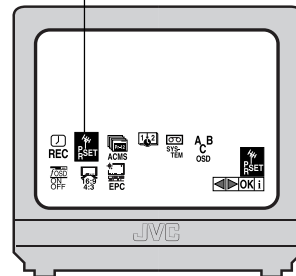

Example: If you moved the station in position 4 to position 2, the stations originally in positions 2 and 3 each move down one space.

CLOSE CONFIRMATION SCREEN Press **MENU**.



Fine-Tuning Stored Channels

GET TO THE MAIN MENU Press **MENU**. Select the icon **PR SET** using the \triangleleft and \triangleright buttons and press **OK**. The Manual Channel Set screen of the channel position currently received appears.

GET TO THE CONFIRMATION SCREEN Press **MENU**.

SELECT ITEM Press the \triangle and ∇ buttons on the Remote Control to select the channel that you wish to fine-tune then press **OK**.

FINE TUNING Press \triangleright to select **MFT** setting. Press the \triangle and ∇ buttons to fine-tune the channel.

SAVE NEW DETAILS Press **MENU** to save the details you have just entered. The Confirmation Screen will appear again.

CLOSE CONFIRMATION SCREEN Press **MENU**.

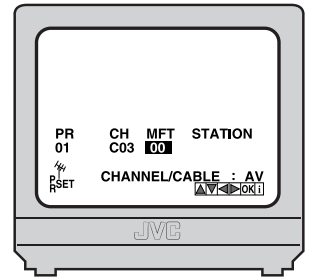

TV Station ID Guide

STATION NAME	ID
3SAT	3SAT
ANT	ANTENA
ARD	ARD
ARTE	ARTE
B1	BERLIN1
BBC1	BBC1
BBC2	BBC2
BR3	BAYERN3
BRTN	BRTN TV1 (Belgium)
CANAL	CANAL PLUS
CAN5	CANALE5
CNN	CNN
DR1	DR1
DR2	DR2
DSF	DSF
EURO	EURONEWS
FILMN	FILM
FR2	France2
FR3	France3
HR3	HESSEN3
HRT	HRT (Croatia)
ITA-1	ITALIA1
KABEL	KABEL1
M6	M6
MDR3	MDR3
MTV	MTV
MTV3	MTV3
N3	NORD3

STATION NAME	ID
N-TV	N-TV
NDR3	NDR3
NED1	NED1
NED2	NED2
NED3	NED3
NET2	Network 2 (Ireland)
NELON	NICKELODEON
NRK	NRK
ORB3	ORB3
ORF1	ORF1
ORF2	ORF2
ORF3	ORF3
PREM.	PREMIERE
PRO7	PRO7
RAI1	RAI1
RAI2	RAI2
RAI3	RAI3
RETE1	RETE1
RETE4	RETE4
RIKIS	Rikisutvarpid-Sjonvarp (Iceland)
RTBF1	RTBF1
RTBF2	RTBF2
RTL	RTL
RTL2	RTL2
RTL4	RTL4
RTL5	RTL5
SAT.1	SAT1
SF1	SF1

STATION NAME	ID
SFB	SFB
SPORT	SPORT
SR6	SR6
SVT	SVT
SVT1	SVT1
SVT2	SVT2
SVT4	SVT4 (Sweden)
SWF3	SWF3
TEL21	TELE21
TELE5	TELE5
TF1	TF1
TMC	TELEMONTECARLO
TNT	TNT INT
TRT	TRT INT
TSI	TSI
TSR	TSR
TV1	BRTN TV1
TV2	TV2
TV3	TV3
TV5	TV5
TVE	TVE (Spain TVE 1/2)
TVE1	TVE1
VIVA	VIVA
VOX	VOX
VTM	VTM
WDR3	West3
YLE1	YLE1
YLE2	YLE2
ZDF	ZDF



TV Station Channel Number Guide

Region	Transmitter	BBC1	BBC2	ITV	CH4	CH5
London & South-East	Bluebell Hill	40	46	43	65	—
	Crystal Palace	26	33	23	30	37
	Dover	50	56	66	53	—
	Heathfield	49	52	64	67	—
	Oxford	57	63	60	53	49
South-West	Beacon Hill	57	63	60	53	—
	Caradon Hill	22	28	25	32	—
	Huntshaw Cross	55	62	59	65	67
	Redruth	51	44	41	47	37
	Stockland Hill	33	26	23	29	—
	Channel Islands Fremont Point	51	44	41	47	—
South	Hannington	39	45	42	66	35
	Midhurst	61	55	58	68	—
	Rowridge	31	24	27	21	—
West	Mendip	58	64	61	54	37
East	Sandy Heath	31	27	24	21	39
	Sudbury	51	44	41	47	35
	Tacolneston	62	55	59	65	52
Midlands	Ridge Hill	22	28	25	32	35
	Sutton Coldfield	46	40	43	50	37
	The Wrekin	26	33	23	29	35
	Waltham	58	64	61	54	35
North	Belmont	22	28	25	32	56
	Emley Moor	44	51	47	41	37
North-West	Caldbeck	30	34	28	32	56
	Winter Hill	55	62	59	65	48
North-East	Bilsdale West Moor	33	26	29	23	35
	Chatton	39	45	49	42	—
	Pontop Pike	58	64	61	54	68
Scotland	Angus	57	63	60	53	—
	Black Hill	40	46	43	50	37
	Sandale	22	—	—	—	—
	Caldbeck	—	34	28	32	56
	Creigkelly	31	27	24	21	48
	Darvel	33	26	23	29	35
	Durris	22	28	25	32	67
	Eitshal	33	26	23	29	—
	Keelylang Hill	40	46	43	50	—
	Knock More	33	26	23	29	—
	Rosemarkie	39	45	49	42	67
	Rumster Forest	31	27	24	21	—
	Selkirk	55	62	59	65	52
	Wales	Blaenplwyf	31	27	24	21
Carmel		57	63	60	53	—
Llanddona		57	63	60	53	—
Moel-y-Parc		52	45	49	42	—
Presely		46	40	43	50	37
Wenvoe		44	51	41	47	—
Northern Ireland	Brougher Mountain	22	28	25	32	—
	Divis	31	27	24	21	37
	Limavady	55	62	59	65	—

Basic Features

Playback.....	24
Playback Features	26
Recording	28
VIDEO Plus+® Timer Programming	31
Timer Programming.....	33

Playback

Playback is the most basic operation possible with your VCR. Audio-visual information recorded on a cassette will be played back on your TV screen just like a broadcast programme.

1 Load a Video Cassette

BEFORE YOU START

Turn the TV on

Tune the TV to your Video Channel or to its AV mode

NTSC TAPES

Some TVs will shrink the picture and place black bars at the top and bottom of the screen. This is not a malfunction but you may lose some on-screen information

The picture may roll up or down. Correct this by adjusting the vertical hold on the TV set

The counter and tape remaining times will be incorrect

The picture will be distorted during search or still mode

Make sure that the window side of the cassette is facing up and the spine label is facing away from the VCR. Insert the cassette as shown in the diagram below; don't use too much force. If the VCR was turned off before you inserted the cassette, the power will come on automatically.

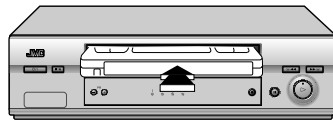

The counter on the TV screen will reset to read '0:00:00'. If the record safety tab on the video cassette has been removed, playback begins automatically.

2 Play

If the cassette that you inserted does not start playing automatically, press the ► button on the VCR or the Remote Control.

- If the tape reaches its end during playback, the VCR stops playback, rewinds the tape and ejects the cassette, then enters the standby mode automatically.

3 Stop & Eject

STOP Press the ■/▲ button on the VCR or the ■ button on the Remote Control once to stop playback.

EJECT Press the ■/▲ button on the VCR a second time or the ▲ button on the Remote Control to eject the cassette from the VCR. The cassette will take about 6 seconds to appear once the ■/▲ button has been pressed.

4

Rewind and Fast Forward

REWIND Press the ◀◀ button on the VCR or on the Remote Control.

FAST FORWARD Press the ▶▶ button on the VCR or on the Remote Control.

- If you press and hold ◀◀ button or ▶▶ button during rewinding or fast-forwarding, you can see the picture on the TV screen. Releasing it cancels the picture search and resume rewinding and fast-forwarding.



Video Heads Cleaning

Use a dry cleaning cassette — JVC TCL-2 — in the following cases:

- Rough, poor picture appears while a tape is played back.
- The picture is unclear or no picture appears.

Playback Features

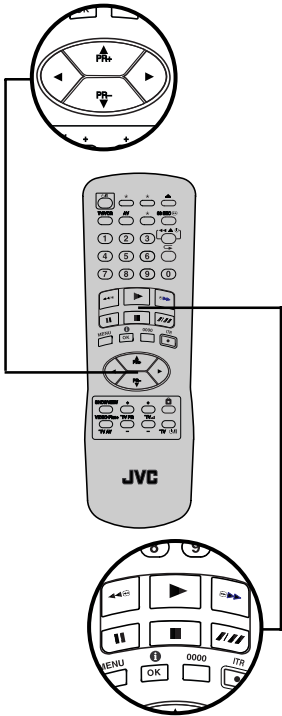

1 Pause During Playback

Press the **||** button on the VCR or the Remote Control.

- The VCR enters Pause mode after moving two or three frames.
- If the paused picture on the TV screen jumps vertically, press the **PR+** and **-** buttons on the Remote Control until the picture is steady.
- Still picture stops automatically after about 5 minutes to protect the heads.
- Press **▶** to resume playback.

2 High Speed Search

During playback or still picture, press the **▶▶** on the Remote Control for forward high speed search, or the **◀◀** button for reverse high speed search.

- High-speed search stops automatically about 3 minutes to protect the heads, then normal playback resumes.
- Press **▶** to resume playback.

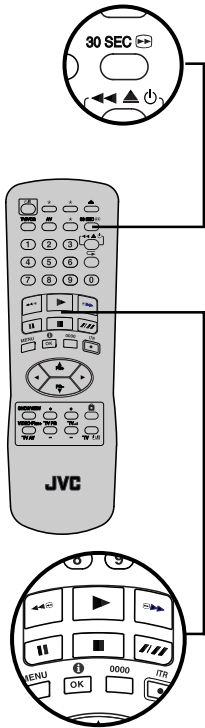

3 Skip Search

During playback, press **30 SEC** (▶) up to 6 times. Each press of the **30 SEC** (▶) button will cause the VCR to go into fast-motion playback for a period of 30 seconds. When the specified portion of the tape is skipped, normal playback resumes automatically.

- To return to normal playback during a Skip Search, press ▶.

! Attention

In the high speed search or still mode,

- the picture will be distorted
- the noise bars will appear
- there will be a loss of colour with an LP-recorded tape

Recording

TV signals being received by the recorder's built in tuner can be recorded onto a video tape. You can 'capture' a TV programme using your VCR.

1

Choose a Programme

BEFORE YOU START

Turn the TV on

Tune the TV to your Video Channel or to its AV mode

Choose a blank cassette which has the record safety tab still in place

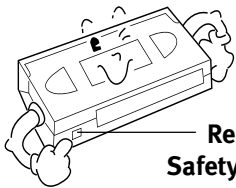

Record Safety Tab

Load the cassette into the VCR (see page 24)

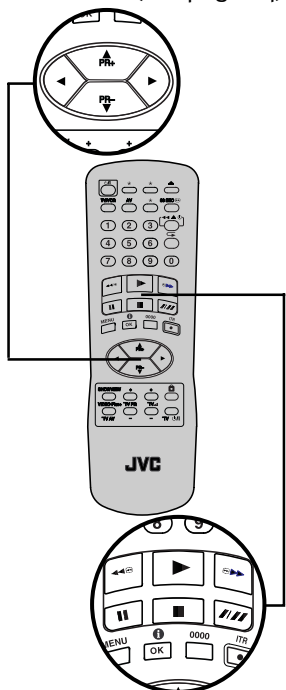

Select the channel that you wish to record.

REMOTE CONTROL Press **PR +/-** or the number keys.

VCR Press **PR +/-**.

2

Set the Tape Speed

Press **///**.

Check the on-screen display until the required tape speed is shown. You can choose Standard Play (SP) or Long Play (LP). The picture quality on LP recordings will not be as high as on SP recordings, but the tape will last longer.

3

Start Recording

Press **●** on the VCR or on the Remote Control.

- If the tape reaches its end during recording, the VCR stops recording, rewinds the tape and ejects the cassette, then enters the standby mode automatically.

4

Pause and Resume During Recording

On either the VCR or the Remote Control, press **||** to temporarily stop recording and press **||** to resume. You cannot change the preset position on the VCR while it is recording but you can while it is paused (see **Choose a Programme** at the top of this page).

- There will be a loss of color, or the picture will be distorted where the channel is changed.

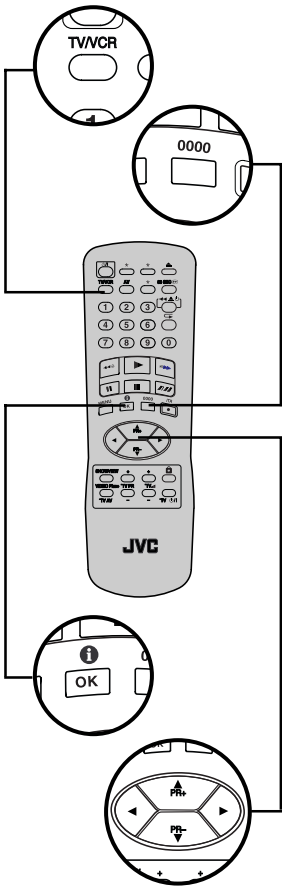

! Notes on Recording

When using both the RF and SCART cables, you can switch between TV and VCR by pressing the **TV/VCR** button on the Remote Control.

* Display Tape Position/Time Counter

Press the **OK** button repeatedly to display the tape position and time counter on the TV screen. To reset the time counter, press **0000**.

NOTES:

- Set **OSD** to **ON** to display the indications on the TV screen. (pg. 41)
- Depending on the type of tape used, the tape position may not appear right away.

* Change Display Information

By pressing the **OK** button repeatedly, you can change the TV screen between the clock time and the tape position/time counter.

* Resetting the Counter

Press the **OK** button so that the counter display appears on the TV screen. While the display is shown, press the **0000** button. You can reset the counter to '0:00:00' before starting playback or recording.

* Record a Programme While Watching Another

If your VCR is connected to the TV with both the RF cable and 21-pin SCART cable, press **TV/VCR**.

Once you have started recording all you need to do is use the controls on your TV set to tune to a different programme. The programme set using the **PR** button on the Remote Control is the one which will be recorded.



Instant Timer Recording

This method allows you to quickly set the VCR to record in 30 minute increments.

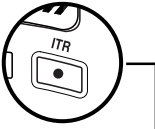

START RECORDING Press ● (ITR) once. If left in this state, the VCR will keep recording until the tape runs out.

ENGAGE INSTANT TIMER RECORDING Press ● (ITR) again. This means that the VCR will record for 30 minutes on the programme already selected and then stop automatically.

INCREASE TIME Each time ● (ITR) is pressed, the time limit is increased by 30 minutes to a maximum of 9 hours.

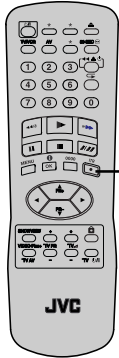

VIDEO Plus +[®]

Timer Programming

BEFORE YOU START

Make sure that the VCR's clock is set correctly

Insert a cassette with the safety tab in place

Turn on the TV and select the Video channel or the AV Mode

Set **SYSTEM** to the appropriate mode. (pg. 43)

The VIDEO Plus+ system uses the code numbers – called PlusCodes – printed after each programme in your TV listings guide. These are a kind of shorthand for video recorders and using them automatically sets your VCR to record the correct programme, channel and time. Up to 7 timer recording programmes within a month can be made.

1 Get to the VIDEO Plus + Screen

Press **VIDEO Plus+**. You will see the following TV screen information.

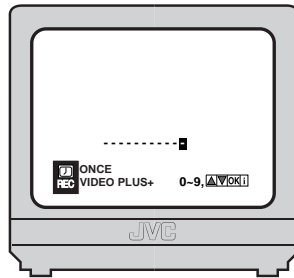

Press Δ ∇ to select **ONCE** (once), **DAILY** (Monday–Friday) or **WEEKLY** (weekly serials).

2 Enter the PlusCode Number

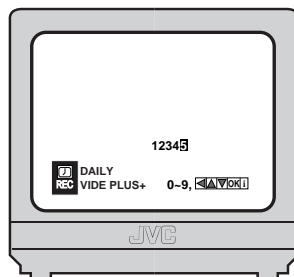

Press the number keys on the Remote Control to enter the PlusCode number of the programme you wish to record, then press **OK**. The programme list appears.

- If you make a mistake, press \triangleleft to delete the incorrect number and then enter the correct one.
- If the number you entered is invalid, **PLEASE CHECK** appears on the TV screen. Input a valid PlusCode number, then press **OK**.

CONTINUED TO NEXT PAGE

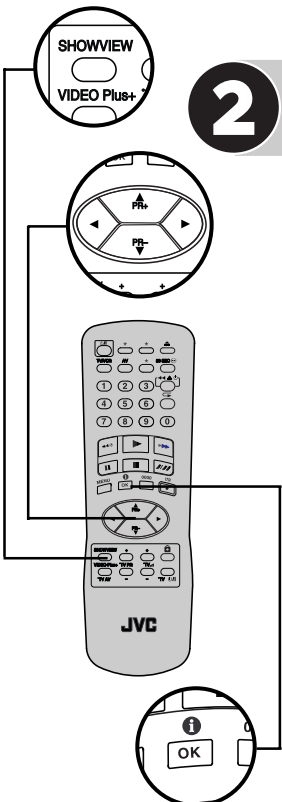

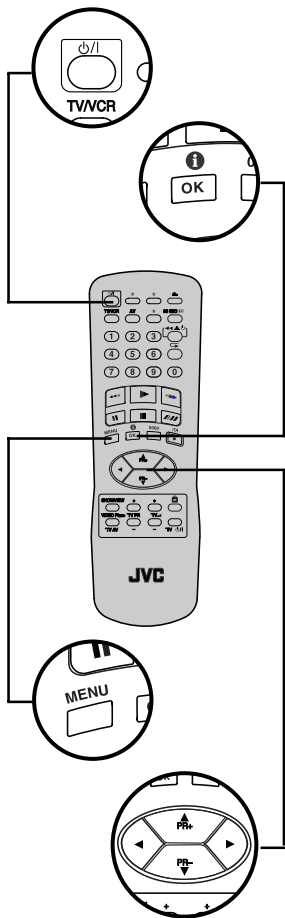

3 Check the Results

Make sure that the preset number displayed is the one that you want. If it is incorrect, the wrong programme will be recorded. If it is incorrect or “--” is displayed, select the appropriate number using the Δ and ∇ buttons. This preset position is registered to the VCR.

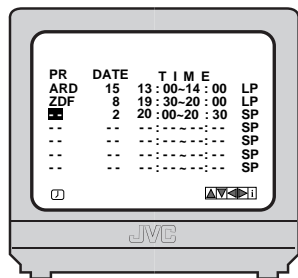

CHANGE PRESET POSITION Press \triangle \triangleright to select the preset number. You can change the preset position using number keys or \triangle and ∇ buttons.

CHANGE DATE Press \triangle \triangleright to select the date. You can change the date using number keys or \triangle and ∇ buttons.

To change the daily (Monday–Friday) or weekly serials, press \triangle \triangleright to select the date setting, then press **OK**. Press \triangle \triangleright , then press **OK**.

CHANGE START TIME Press \triangle \triangleright to select the start time. You can compensate for anticipated changes in schedule using the number keys or \triangle and ∇ buttons.

CHANGE STOP TIME Press \triangle \triangleright to select the stop time. You can compensate for anticipated changes in schedule using the number keys or \triangle and ∇ buttons.

SET TAPE SPEED Press \triangle \triangleright to select the tape speed. You can change the tape speed between Standard Play (SP), Long Play (LP) and Intelligent Play (IP) using the \triangle and ∇ buttons. (see pg. 34, **Intelligent LP Recording**)

CAPACITY You can set this VCR to timer record up to seven programmes. If you try to enter a eighth, **PROGRAM FULL** appears on the TV screen.

4 Return to Normal Screen

Press **MENU** twice.

5 Engage Timer Mode

You must now put the VCR into Timer Mode by pressing $\odot/|$ otherwise no recording will take place. The timer indicator and standby/record indicator light on the display panel. To disengage the Timer Mode, press $\odot/|$ again.

- If a cassette has not loaded when the VCR enters the Timer Mode, the timer indicator blinks on the display panel.

Timer Programming

If you do not know the PlusCode number for the programme that you wish to record, follow the instructions below to manually set your VCR to record.

BEFORE YOU START

Make sure that the VCR's clock is set correctly

Insert a cassette with the safety tab in place

Turn on the TV and select the Video channel or the AV Mode

Set **SYSTEM** to the appropriate mode. (☞ pg. 43)

1 Get to the Programme List

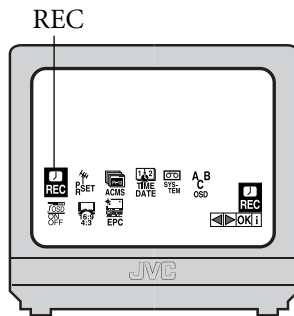

Press **MENU**. Select the icon **REC** using the ◀ and ▶ buttons and press **OK**.

2 Enter Programme Details

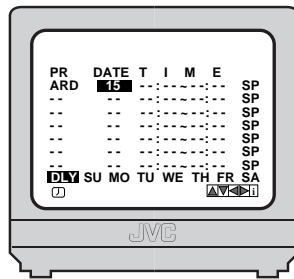
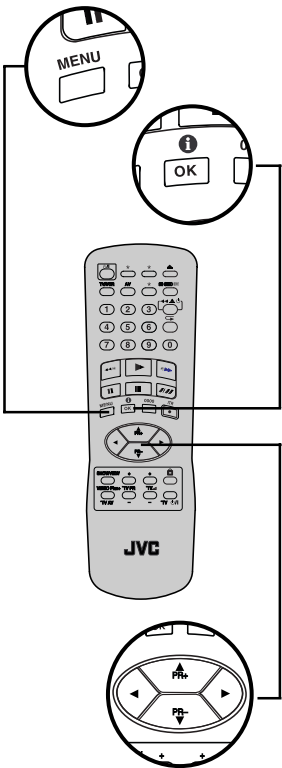

Select the open row then press **OK** again.

SET PROGRAMME Press the number keys to enter the programme required.

SET DATE Press the number keys to adjust the date.

To time-record daily (Monday–Friday) or weekly serials, press ◀ ▶ to select the date setting, then press **OK**. Press ◀ ▶, then press **OK**.

SET START TIME Press the number keys to enter the start time.

SET STOP TIME Press the number keys to enter the stop time.

SET TAPE SPEED Press ◀ ▶ to select the tape speed. You can change the tape speed between Standard Play (SP), Long Play (LP) and Intelligent Play (IP) using the ▲ and ▼ buttons. (☞ pg. 34, **Intelligent LP Recording**)

NOTE:

Input “o” before any single number entries.

For memory capacity and Serial Programming, see **VIDEO Plus+ Timer Programming** on page 31.

3 Return to Normal Screen

Press **MENU** twice.

4 Engage Timer Mode

You must now put the VCR into Timer Mode by pressing $\odot/|$ otherwise no recording will take place. The timer indicator and standby/record indicator light on the display panel. To disengage the Timer Mode, press $\odot/|$ again.

- If a cassette has not loaded when the VCR enters the Timer Mode, the timer indicator blinks on the display panel.

* Intelligent LP Recording

When you set the tape speed to **LP**, the VCR automatically switches to LP mode to allow complete recording if there is not enough tape to record the entire programme while timer-recording in **SP** mode.

For example, recording a programme of 210 minutes in length onto a 180-minute tape.

Approximately 150 minutes	Approximately 60 minutes
SP mode	LP mode
Total 210 minutes	

NOTES:

- If you have programmed the VCR to timer-record 2 or more programmes, do not use this function, but change the tape speed manually during timer programming.
- There may be some noise and sound disturbance where the tape speed switches from SP to LP mode on the tape.
- This function is not available during ITR (Instant Timer Recording), and will not work properly with any tapes longer than E-180 or with some tapes of shorter lengths.

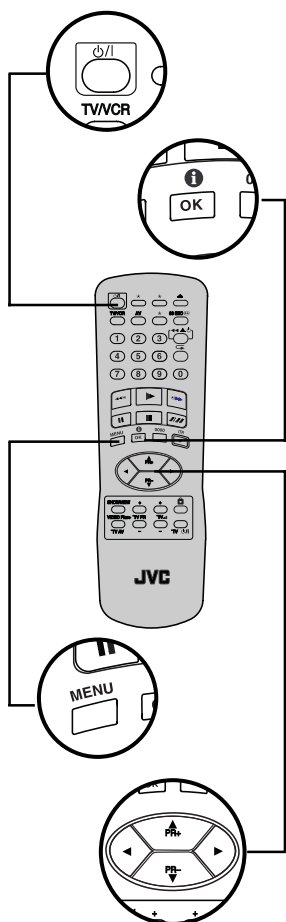

! Notes on Timer Recording

- If there is a conflict in the timer schedule and one programme overlaps with another, the programme starting earlier will be recorded. If the start times are the same, the programme made most recently will be recorded.
- If you wish to stop timer recording which has already started, press $\odot/|$.
- After timer recording is completed, the VCR enters the standby mode automatically.
- If the tape reaches its end during timer recordings, the VCR stops recording, rewinds the tape and ejects the cassette, then enters the standby mode automatically.
- You can programme the timer recording while a regular recording is in progress; the menu screens will not be recorded.

* Check, Cancel & Change Programmes

Press $\odot/|$ to disengage the timer mode.

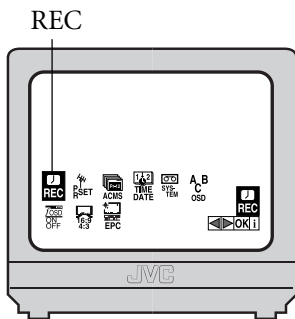

GO TO THE PROGRAMME LIST Press **MENU**. Select the icon **REC** using the \triangleleft and \triangleright buttons and press **OK**.

CANCEL A PROGRAMME Press $\triangle\triangledown$ to select the programme you want to delete. Press \triangleleft to cancel a programme.

CHANGE A PROGRAMME Press $\triangle\triangledown$ to select the programme you want to change, then press **OK**. Press \triangleleft \triangleright to select the item you want to change, then press the number keys and \triangle and \triangledown buttons to change the settings.

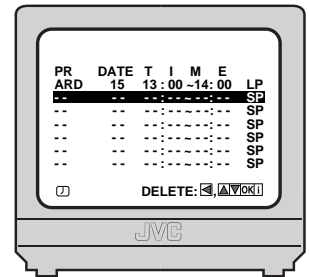

RETURN TO NORMAL SCREEN Press **MENU** twice.

RETURN TO TIMER MODE If there are still programmes to be recorded, press $\odot/|$.

Advanced Features

Picture Quality	38
Editing	39
Other Functions	41

Picture Quality



Manual Tracking

Your VCR is equipped with automatic tracking control. This will be adequate for most tapes and will automatically adjust the tracking to suit the particular tape in use but if you insert an old or worn tape, it may be necessary to manually adjust the tracking in order to get the best picture. If automatic tracking fails, you will notice noise bars appearing across the picture; you can correct this by manually overriding the tracking using the following steps.

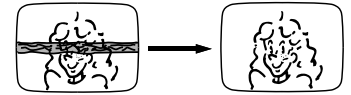

ADJUST TRACKING MANUALLY During playback, use the **PR +** or **-** buttons to adjust the tracking manually.

NOTE:

When a new tape is inserted, the VCR returns to automatic tracking.



Picture Control

This feature allows you to select the most appropriate picture quality according to the type of tape or use of this VCR. The default setting is **OFF**.

GET TO THE MAIN MENU Press **MENU**. Select the icon **EPC** using the **◀** and **▶** buttons and press **OK**.

SELECT PICTURE CONTROL MODE Select the desired mode using the **△** and **▽** buttons and press **◀** or **▶**.

- OFF:** Picture quality is not adjusted.
- SOFT:** Reduces image coarseness when viewing overplayed tapes containing lots of noise.
- SHARP:** Clearer, sharper-edged picture when viewing images with lots of flat, same-coloured surfaces such as cartoons.

RETURN TO NORMAL SCREEN Press **MENU**.

NOTE:

You can perform EPC setting only during playback.

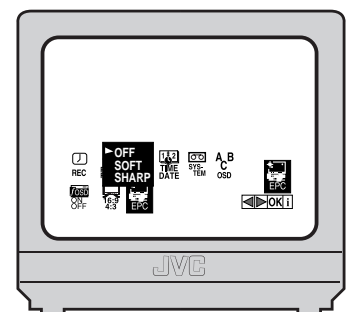
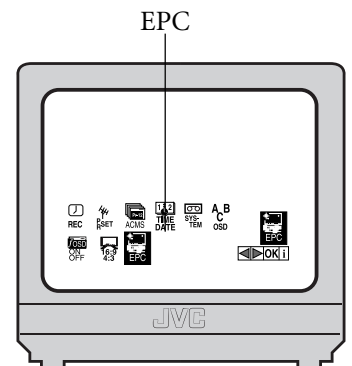

Editing



Editing Using Another VCR

CONNECT UP Connect **EURO AV1 AUDIO/VIDEO** connector to another VCR.

SET RECORDER INPUT MODE The recording VCR mode must be set to **AUX**. If this VCR is the recorder, press **AV** and /or **PR** to select **AV1**. If this VCR is the player, set **OSD** to **OFF**. (☞ pg. 41)

START SOURCE VCR Engage its **PLAY** mode.

START RECORDING VCR Engage its **RECORD** mode.

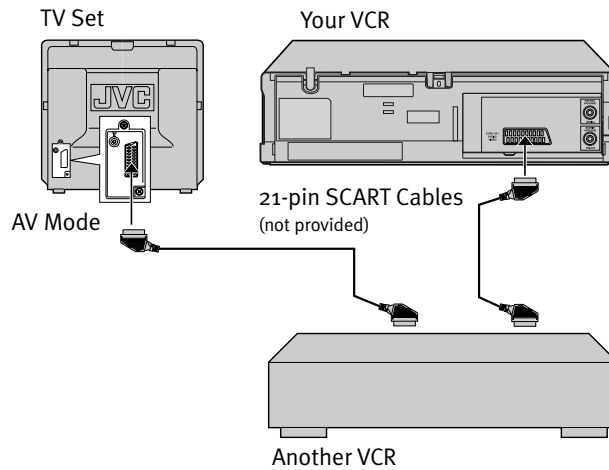



Editing From a Camcorder

CONNECT UP Connect the Camcorder's **AUDIO/VIDEO OUT** connector to the VCR's rear panel **EURO AV1 AUDIO/VIDEO** connector, via an optional cable adapter.

SET INPUT MODE Press **AV** or **PR** so that **AV1** appears in the place of a preset position number.

START CAMCORDER Engage the camcorder's **PLAY** mode.

START RECORDER Press ●.

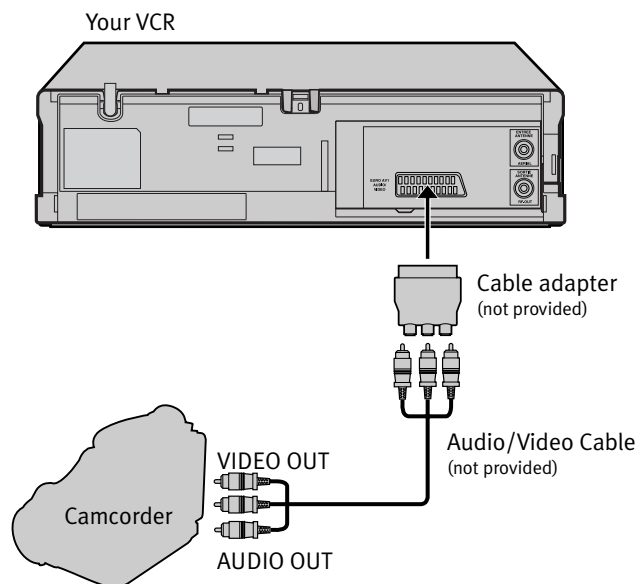

Other Functions



On-Screen Display (OSD)

This function allows you to turn the on-screen information **ON** or **OFF**.

GET TO THE MAIN MENU Press **MENU**. Select the icon **OSD** using the \triangleleft and \triangleright buttons and press **OK**.

ENABLE/DISABLE OSD The default setting for **OSD** is **ON**. Press \triangleup and \triangledown to toggle between **ON** and **OFF** and press \triangleleft or \triangleright .

RETURN TO NORMAL SCREEN Press **MENU**.

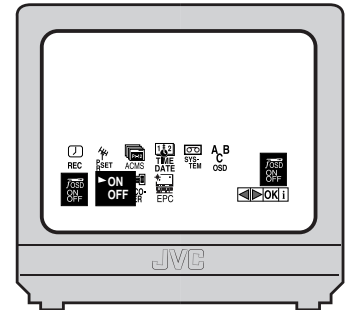

GUIDE TO ON-SCREEN DISPLAY INFORMATION

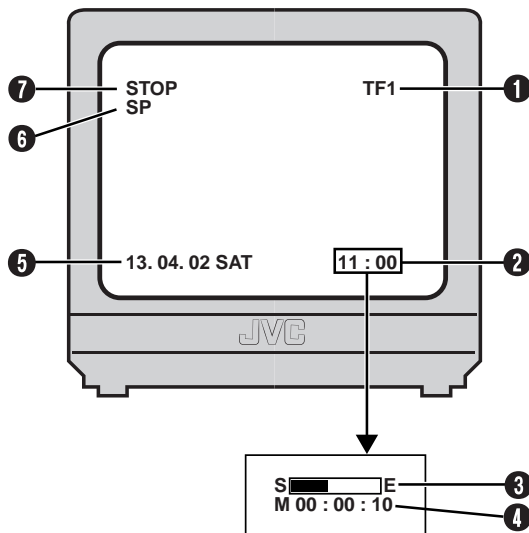

If you press **1** (**OK**) on the Remote Control when **OSD** is set to **ON**, you can see the current VCR status on the TV screen. The indications except the clock or time counter disappears in about 5 seconds. To clear the on-screen display completely, press **1** (**OK**) again. The indications are not recorded even if the VCR is in the recording mode.

- 1** Channel and auxiliary input
- 2** Clock*
- 3** Tape position*
- 4** Time counter*
 - * Each time you press **1** (**OK**), the display shows clock or tape position and time counter alternatively.
- 5** Current day/month/year
- 6** Tape speed
- 7** VCR operation mode
 - PLAY:** appears during playback.
 - REW:** appears during rewinding, or blinks during rewinding with Rewind Power Off function. (pg. 42)
 - FF:** appears during fast-forwarding.

- EZ REPEAT:** appears during Ez repeat playback. (pg. 42)
- EJECT:** appears when you eject the cassette.
- STOP:** appears when you stop playback or recording.
- RECORD:** appears during recording.
- RECP:** appears in the record pause mode.
- SAFE:** appears when the VCR enters in child lock mode, or any buttons on the VCR are pressed during child lock mode. (pg. 44)



Rewind Power Off

When the tape is not running, press ◀◀, then press ⏻/|. **REW** blinks on the TV screen. The VCR enters the standby mode automatically after rewinding the tape.



Ez (Easy) Power Off

During playback, press ◀◀▶⏻. The VCR stops playback, rewinds the tape and ejects the cassette, then enters the standby mode automatically.



Ez (Easy) Repeat Playback

During playback, press and hold ⇐. The VCR starts the reverse search. Release this button at the point you want repeat playback to start. The VCR repeats the selected scene twice. During Ez repeat playback, **EZ REPEAT** appears on the TV screen.



Memory Stop Facility

The VCR stops automatically when rewinding the tape and the counter reaches “M 0:00:00”. If you set the counter to “M 0:00:00” before the playback or recording, you can easily access the pre-selected position by using the time counter.

- Press **OK** repeatedly to display the counter on the TV screen.
- Press **0000** to reset the counter before playback or recording.
- Start playback or recording.
- Press **◀◀** after playback or recording. The tape rewinds and stops automatically when the counter reaches to “M 0:00:00”.



Colour System

You can play back PAL, NTSC and MESECAM tapes, or record PAL and SECAM* signals on this VCR. Select the appropriate colour system.

* SECAM signals will be recorded as MESECAM on this VCR; MESECAM is the designation for tapes with SECAM signals that have been recorded on a MESECAM-compatible PAL video cassette recorder.

GET TO THE MAIN MENU Press **MENU**. Select the icon **SYSTEM** using the ◀ and ▶ buttons and press **OK**.

SELECT MODE Press △▽ to select the appropriate mode and press ◀ or ▶ .

AUTO: Normally select this. The appropriate colour system is selected automatically depending on the playback or recording signals.

If “AUTO” does not work correctly, set the following mode manually.

PAL: To record PAL signals, or playback a PAL.

MESECAM: To record SECAM signals, or play back a MESECAM tape.

RETURN TO NORMAL SCREEN Press **MENU**.



16:9 Compatibility

You can select the aspect ratio of your TV.

GET TO THE MAIN MENU Press **MENU**. Select the icon **16:9/4:3** using the ◀ and ▶ buttons and press **OK**.

SELECT MODE Press △▽ to select the appropriate mode and press ◀ or ▶.

AUTO: Normally select this. You can play back the 16:9 and 4:3 screen-programme as they are.

16:9: You can play back the programme with the 16:9 screen format.

4:3: You can play back the programme with the 4:3 screen format.

NOTE:

Set your TV to its AV mode if the picture is cut off on the TV screen when you play back the programme with the 16:9 screen format.

RETURN TO NORMAL SCREEN Press **MENU**.



Child Lock

You can disable the VCR's operations. While the VCR is turned on, press  on the Remote Control. **SAFE** appears on the TV screen.

To release the child lock, press  until the power indicator blinks on the display panel.

If any buttons on the VCR are pressed while the child lock function is activated, **SAFE** appears on the TV screen and the power indicator blinks on the display panel.

NOTES:

- When the child lock function is in use, the VCR's operations are possible only with the Remote Control. Keep the Remote Control out of the children's reach.
- Timer recording programmes will be performed even if the child lock function is activated.

Questions and Answers

PLAYBACK

Q: What happens if the end of the tape is reached during playback or search?

A: *The VCR stops playback, rewinds the tape and ejects the cassette, then enters the standby mode automatically.*

Q: Can the VCR indefinitely remain in the still mode?

A: *No. It stops automatically after 5 minutes to protect the heads.*

Q: During search or still, I can't hear any audio. What's the problem?

A: *This is normal.*

Q: When returning from high speed search to normal playback, the picture is disturbed. Should I be concerned about this?

A: *No, it is normal.*

Q: Noise bars appear during high speed search. What's the problem?

A: *This is normal.*

RECORDING

Q: When I pause and then resume a recording, the end of the recording before the pause is overlapped by the beginning of the continuation of recording. Why does this happen?

A: *This is normal. It reduces distortion at the pause and resume points.*

Q: Can the VCR indefinitely remain in the Record-Pause mode?

A: *No. It stops automatically after 5 minutes to protect the heads.*

Q: What happens if the tape runs out during recording?

A: *The VCR stops recording, rewinds the tape and ejects the cassette, then enters the standby mode automatically.*

TIMER RECORDING

Q: The timer indicator and the standby/record indicator remain lit on the display panel. Is there a problem?

A: *No. This is a normal condition for a timer recording in progress.*

Q: Can I programme the timer while I'm watching a tape or a TV broadcast?

A: *You won't see the picture as it is replaced by the on-screen menu, but the audio from the program or tape you're viewing can be heard.*

Troubleshooting

SYMPTOM	POSSIBLE CAUSE	CORRECTIVE ACTION
POWER		
1. No power is applied to the VCR.	<ul style="list-style-type: none"> The mains power cord is disconnected. 	Connect the mains power cord.
2. The Remote Control won't function.	<ul style="list-style-type: none"> The batteries are discharged. 	Replace the dead batteries with new ones.
TAPE TRANSPORT		
1. The tape does not run during recording. RECP appears on the TV screen (only when OSD is set to ON).	<ul style="list-style-type: none"> The VCR is in the RECORD PAUSE MODE. 	Press II to resume recording.
2. The tape will not rewind or fast-forward.	<ul style="list-style-type: none"> The tape is already fully rewound or fast-forwarded. 	Check the cassette.
PLAYBACK		
1. The playback picture does not appear while the tape is running.	<ul style="list-style-type: none"> If you're using only the RF cable for connection... <ul style="list-style-type: none"> ...the TV's channel selector is not set to the Video Channel. ...the VCR's Video Channel has not been correctly set. If you're using both the RF cable and 21-pin SCART cable for connection, the TV is not set to the AV mode. 	<p>If you are using only the RF cable for connection... ...set the TV to the Video Channel. ...Perform Video Channel Set. (🔍 pg. 14)</p> <p>If you are using both the RF cable and 21-pin SCART cable for connection, set the TV to its AV mode.</p>
2. Noise appears during visual search.	<ul style="list-style-type: none"> This is normal. 	
3. Noise appears during normal playback.	<ul style="list-style-type: none"> The automatic tracking mode is engaged. 	Try manual tracking. (🔍 pg. 38)
4. The playback picture is blurred or interrupted while TV broadcasts are clear.	<ul style="list-style-type: none"> The video heads may be dirty. 	Use a dry cleaning cassette JVC TCL-2 or consult your JVC dealer.

SYMPTOM	POSSIBLE CAUSE	CORRECTIVE ACTION
RECORDING		
1. Recording cannot be started.	<ul style="list-style-type: none"> • There is no cassette loaded, or the cassette loaded has had its record safety tab removed. 	Insert a cassette, or using adhesive tape, cover the hole where the tab was removed.
2. TV broadcasts cannot be recorded.	<ul style="list-style-type: none"> • AV1 has been selected as the input mode. 	Set to the desired preset.
3. Tape-to-tape editing is not possible.	<ul style="list-style-type: none"> • The source (another VCR, camcorder) has not been properly connected. • All necessary power switches have not been turned on. • The input mode is not correct. 	<p>Confirm that the source is properly connected.</p> <p>Confirm that all units' power switches are turned on.</p> <p>Set the input mode to AV1.</p>
4. Camcorder recording is not possible.	<ul style="list-style-type: none"> • The camcorder has not been properly connected. • The input mode is not correct. 	<p>Confirm that the camcorder is properly connected.</p> <p>Set the input mode to AV1.</p>
TIMER RECORDING		
1. Timer recording won't work.	<ul style="list-style-type: none"> • The clock and/or the timer have been set incorrectly. • The timer is not engaged. • The loaded cassette has had its record safety tab removed. 	<p>Re-perform the clock and/or timer settings.</p> <p>Press  and confirm that the timer indicator is displayed on the display panel.</p> <p>Remove the cassette and cover the hole with adhesive tape, or insert a cassette with the record safety tab intact.</p>
2. The timer indicator blinks on the display panel.	<ul style="list-style-type: none"> • The timer is engaged but there's no cassette loaded. 	Load a cassette with the record safety tab intact.
3. Timer programming is not possible.	<ul style="list-style-type: none"> • Timer recording is in progress. 	Timer programming can't be performed while a timer recording is in progress. Wait until it finishes.
4. The VCR stops timer recording, rewinds the tape and ejects the cassette, then enters the standby mode automatically.	<ul style="list-style-type: none"> • The end of the tape was reached during timer recording. 	The programme may not have been recorded in its entirety. Next time make sure you have enough time on the tape to record the entire programme.
5. The VIDEO Plus+ system does not timer record properly.	<ul style="list-style-type: none"> • The VCR's preset positions have been set incorrectly. 	Set the preset position manually. That preset position is registered to the VCR. Then re-perform the procedure.

SYMPTOM	POSSIBLE CAUSE	CORRECTIVE ACTION
OTHER PROBLEMS		
1. Whistling or howling is heard from the TV during camcorder recording.	<ul style="list-style-type: none"> • The camcorder's microphone is too close to the TV. • The TV's volume is too high. 	Position the camcorder so its microphone is away from the TV. Turn the TV's volume down.
2. When scanning channels, some of them are skipped over.	<ul style="list-style-type: none"> • Those channels have been designated to be skipped. 	If you need the skipped channels, restore them.
3. The preset cannot be changed.	<ul style="list-style-type: none"> • Recording is in progress. 	Press to pause the recording, change presets, then press to resume recording.
4. Channel settings that were made manually seem to have changed or disappeared.	<ul style="list-style-type: none"> • After the manual settings were made, Auto Channel Set was performed. 	Perform manual setting again.
5. No channels are stored in the VCR's memory.	<ul style="list-style-type: none"> • The TV aerial cable was not connected to the VCR when Plug&Play Setup was performed. 	Turn off the VCR once and connect the TV aerial cable to the VCR properly, plug the main power cord into a main outlet again. Then perform Plug&Play Setup again (☞ pg. 10).

List of Terms

A		O	
Auto Channel Setup	17	On-Screen Display (OSD)	41
C		P	
Change Display Information	29	Pause During Playback	26
Change Station Name	19	Picture Control	38
Change Station Preset Position	20	Playback	24
Check, Cancel & Change Programmes	35	Plug&Play Setup	10
Child Lock	44	PlusCode Number	31
Clock Set	16	R	
Colour System	43	Record a Programme While Watching Another	29
D		Recording	28
Delete a Channel	19	Resetting the Counter	29
Display Tape Position/Time Counter	29	Rewind Power Off	42
E		S	
Editing From a Camcorder	40	Skip Search	27
Editing Using Another VCR	39	T	
Ez (Easy) Power Off	42	Timer Programming	33
Ez (Easy) Repeat Playback	42	Tuner Set	17
F		TV Station Channel Number Guide	22
Fine-Tuning Stored Channels	21	TV Station ID Guide	21
H		V	
High Speed Search	26	Video Channel Set	14
I		Video Heads Cleaning	25
Instant Timer Recording	30	VIDEO Plus+® Timer Programming	31
Intelligent LP Recording	34		
L		16:9 Compatibility	44
Language Set	15		
M			
Manual Channel Setup	18		
Manual Tracking	38		
Memory Stop Facility	43		
N			
NTSC Tapes	24		

SPECIFICATIONS

GENERAL

Power: 200 V – 240 V, 50 Hz/60 Hz
Power consumption : Power on : Approx. 12 W : Standby mode:3.0 W
Video Head system : Rotary two-head helical scan system
Tape speed
(SP) : 23.39 mm/sec
(LP) : 11.69 mm/sec
Tape format : Tape width 1/2" (12.7 mm high density VHS tape)
Maximum recording time
(SP) : 240 min. with E-240 video cassette
(LP) : 480 min. with E-240 video cassette
Rewind time : Approx. 180 sec. with E-180 cassette
Dimensions (W x H x D) : 360 mm x 94.5 mm x 270 mm
Weight : 4.0 kg
Operating temperature : 5 °C to 35 °C
Operating humidity : Less than 80 %
Timer: 24 hours display type

VIDEO

Signal system: PAL-type colour signal and CCIR monochrome signal, 625 lines 50 fields
Recording Format : PAL I
RF reception : PAL I
RF OUT : PAL I
RF modulator: UHF channels 22 – 68 (Adjustable)
Input level : VIDEO IN (SCART type) 1.0 Vp-p, 75 ohm, unbalanced
Output level : VIDEO OUT (SCART type) 1.0 Vp-p, 75 ohm, unbalanced
Signal-to-noise ratio : More than 43 dBm

AUDIO

Input level : AUDIO IN (SCART type) –6.0 dBm, more than 10 kΩ
Output level : AUDIO OUT (SCART type) –6.0 dBm, less than 1 kΩ
Audio track : Mono track
Audio frequency response : 100 Hz to 10,000 Hz (–6/+3 dBm)

ACCESSORIES

Provided accessories : RF cable, Infrared remote control unit, "AAA" battery x 2

Specifications shown are for SP mode unless otherwise specified.
E.& O.E. Design and specifications subject to change without notice.

JVC
VICTOR COMPANY OF JAPAN, LIMITED